

K610

4-DIGIT NUMERATOR BLOCK



Materials:

(1-2) Numerator case:

Glass fiber reinforced polyamide.
Resistant to oils and greases.

(3) Grub screw:

K610: Steel C45
K610CIN: Stainless steel (Aisi 304).

(4) Shaft connector:

K610: Free-cutting steel.
K610CIN: Stainless steel (Aisi 303).

(4) Window:

Polymethylmethacrylate (PMMA).

(4) Number wheels:

Polyamide.

Colour:

(1) Case cover:

Black (RAL 9011 code 01)

(2) Case:

K610: Black (RAL 9011 cod. 01).

K612: Orange (RAL 2004 cod. 02).

K613: Grey (RAL 7035 cod. 13).

(3) Grub screw:

K610: Black-oxide treated.
K610CIN: Natural.

(4) Connector

K610: Black-oxide treated.
K610CIN: Natural.

(5) Window:

Transparent.

(6) Number wheels:

Black wheel with white numbers.

Surface finish:

(1-2-6) Smooth.

(4) Fine turned finish.

(5) Glossy, enhanced reading effect.



Mounting or reading position (PL)

Rotation direction (SR)

Number wheel characters:

White pad printed. Character height 4 mm approx.

Gear ratio (GR):

The gear ratio establishes which number must appear on the counter after making a full turn (360°). For example, by choosing a gear ratio of 15, after one revolution on the window you will see digits 015. The position of the decimal point will help reduce the measure, because, choosing one decimal place, the 015 becomes 01.5.

Mounting / reading position (PL):

The numerator block can be applied in four different positions. Please choose the most suitable for your application:

P1 = Vertical, with numbers on upper side

P2 = Vertical, with numbers on vertical side

P3 = Horizontal, with numbers on inclined side

P4 = Horizontal, with numbers on vertical side.

Rotation direction (SR):

O = increase of values with clockwise rotation

A = increase of values with counter clockwise rotation

Decimal point (PD):

The numerator block can also be chosen with decimal point. In this case, with three digits, the decimal position is available in these formats:

PD = 0 - no decimal point indicated (0000)

PD = 1 - one digit after decimal point (000.0)

PD = 2 - two digits after decimal point (00.00)

PD = 3 - three digits after decimal point (0.000)

Base case seal:

Each numerator comes with a base case seal in black polyurethane foam. For additional orders use code K607047.

Special requests:

- Upon request a shaft reducing sleeve K605 can be supplied in black oxide treated steel, diameters available: 04 - 06 - 08 - 10 - 12.
- Upon request it can be supplied with the anti-rotation pin with backlash compensation.
- Upon request an intermediate extension for base case can be supplied separately (K606047).

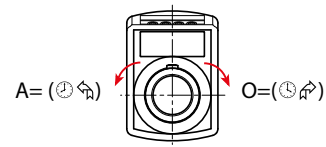

4-digit numerator block, 1 decimal place

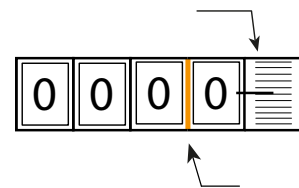

Base case seal included K60747

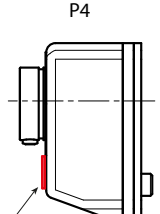
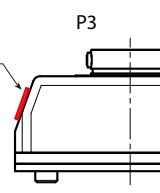
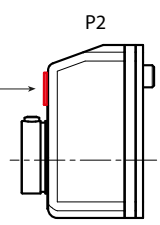
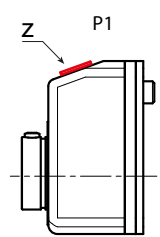

Intermediate extension for base K60647

Reducing sleeve K605



Stock availability as % (🛒)
90% (●) - 40% (●) - 5% (●)

K610

4-DIGIT NUMERATOR BLOCK

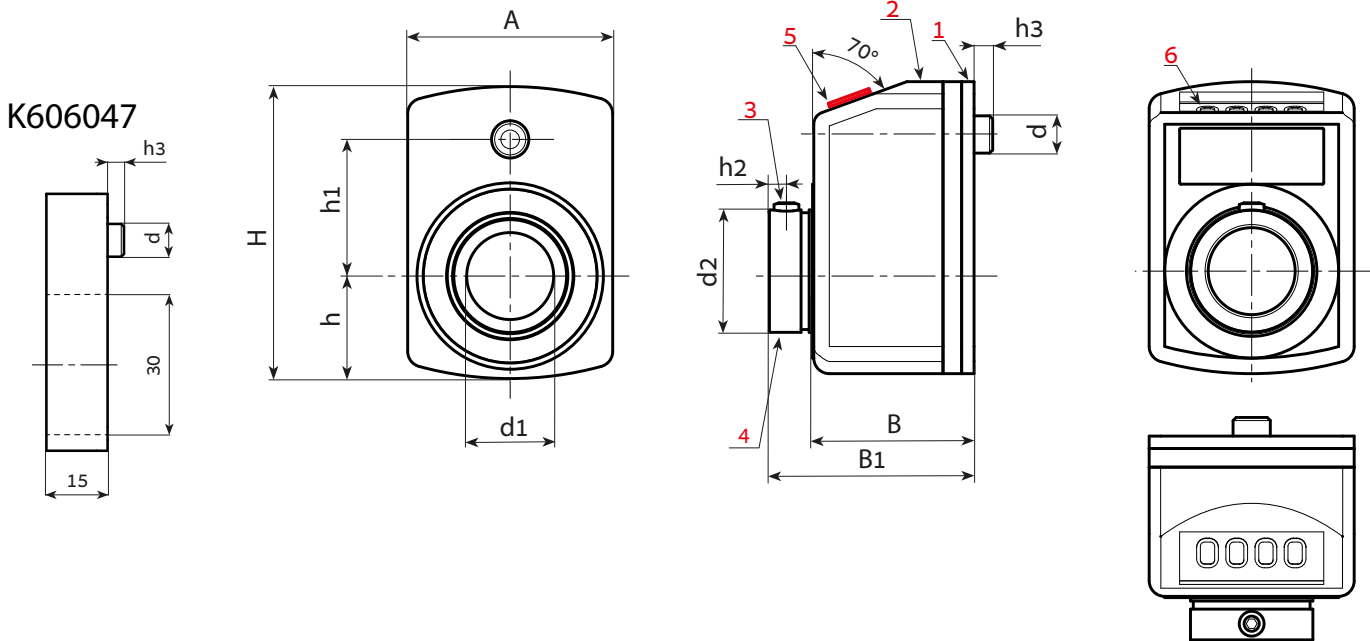

Options to specify in the order (GR-SR-PL-PD)



Stock availability as % (🛒)
90% (●) - 40% (●) - 5% (●)

| art. | H | A | h | h1 | h2 | h3 | B | B1 | d | d2 | d1H7 | GR | SR | PL | PD | 🛒 |
|----------------------|----|----|------|----|-----|----|----|----|---|------|------|---|-----|-------------|---------|----|
| K610047.TD14..... | 47 | 33 | 16,5 | 22 | 2,5 | 5 | 24 | 31 | 6 | 19,7 | 14 | 10-12/5-15-17/5-20-25-30-35-40-50-60-80-100 | O-A | P1-P2-P3-P4 | 0-1-2-3 | 50 |
| K612047.TD14..... | 47 | 33 | 16,5 | 22 | 2,5 | 5 | 24 | 31 | 6 | 19,7 | 14 | 10-12/5-15-17/5-20-25-30-35-40-50-60-80-100 | O-A | P1-P2-P3-P4 | 0-1-2-3 | 50 |
| K613047.TD14..... | 47 | 33 | 16,5 | 22 | 2,5 | 5 | 24 | 31 | 6 | 19,7 | 14 | 10-12/5-15-17/5-20-25-30-35-40-50-60-80-100 | O-A | P1-P2-P3-P4 | 0-1-2-3 | 50 |
| K610047.TD14.....CIN | 47 | 33 | 16,5 | 22 | 2,5 | 5 | 24 | 31 | 6 | 19,7 | 14 | 10-12/5-15-17/5-20-25-30-35-40-50-60-80-100 | O-A | P1-P2-P3-P4 | 0-1-2-3 | 50 |
| K612047.TD14.....CIN | 47 | 33 | 16,5 | 22 | 2,5 | 5 | 24 | 31 | 6 | 19,7 | 14 | 10-12/5-15-17/5-20-25-30-35-40-50-60-80-100 | O-A | P1-P2-P3-P4 | 0-1-2-3 | 50 |
| K613047.TD14.....CIN | 47 | 33 | 16,5 | 22 | 2,5 | 5 | 24 | 31 | 6 | 19,7 | 14 | 10-12/5-15-17/5-20-25-30-35-40-50-60-80-100 | O-A | P1-P2-P3-P4 | 0-1-2-3 | 50 |

Notes: Note: For ratios "/5" the arithmetic values are not displayed.
When ordering, please insert the chosen options in the code points.

Example 1:

Example 1: for a numerator block with 4 digits (K610047) with shaft of 14mm (d1), - orange colour (K612), - with gear ratio (GR) 60; - with clockwise rotation (SR) O, - with reading position (PL) P1, - with no decimal place (PD) 0, the complete code is thus formed: K612047.TD14060OP10.

or

Example 2: for a numerator block with 4 digits (K610047) with stainless steel shaft of 14mm (d1), - grey colour (K613), - with gear ratio (GR) 12/5, - with counterclockwise rotation (SR) A, - with reading position (PL) P2, - with three decimal places (PD) 3, the complete code is thus formed: K613047.TD14125AP23CIN.

Arbel Agencies LTD.



11 Ba'alei Hamelacha st. Qiryat Bialik P.O.B 1095, ZIP 2751311, ISRAEL
+972(0)48736969 ☎ +972(0)48730708 📠 info@arbel-ltd.com 📧 www.arbel-ltd.com 🌐

