

K620-K620CIN



NUMERATOR BLOCK WITH 5 DIGITS

Materials:

- (1-2) Numerator Case:
Reinforced polyamide. Oils and greases resistant.
- (3) Fixing grub screw:
K620: Steel C45.
K620CIN: Stainless steel (AISI 303).
- (4) Connection bush to shaft:
K620: Automatic steel.
K620CIN: Stainless steel (AISI 303).
- (5) Windows:
Polymethylmethacrylate (PMMA).
- (6) Numbered rings:
Polyamide.

Superficie:

- (1-2) Numerator Case: Smooth.
- (4) Connection bush: Smooth by fine turning.
- (5) Windows: Smooth. Enhanced reading effect.

Colours:

- (1) Numerator Case Cover: Black (RAL 9011 cod. 01).
- (2) Numerator Case: K620: Black (RAL 9011 cod. 01).
K622: Orange (RAL 2004 cod. 02).
K623: Grey (RAL 7035 cod. 13).
K620: Black-oxide plating.
K620CIN: Natural.
- (3) Fixing grub screw: K620: Black-oxide plating.
K620CIN: Natural.
- (4) Connection bush: K620: Black-oxide plating.
K620CIN: Natural.
- (5) Windows: Transparent.
- (6) Numbered rings: black collars with white number.

Numbered rings characters:

White pad printed. Character height about 7 mm.

Gear Reduction ratio (GR):

The reduction ratio establishes that number must appear on the counter after making a full turn (360°). For example, by choosing a reduction ratio of 15, after one revolution on the window you will see the 015 number. The position of the decimal will help demultiplex the measure, because choosing one decimal place, the 015 becomes 01,5.

Mounting/Reading position (☞):

The numerator block can be applied in four different positions.

Please choose the most suitable for your application:

- P1 = Vertical with numbers on upper part,
- P2 = Vertical with numbers on vertical,
- P3 = horizontal with numbers in inclined wall,
- P4 = horizontal with numbers in vertical wall.

Rotation direction:

O= (⌚) increase the values with clockwise rotation,
A= (⌚) increase the values with counterclockwise rotation.

Decimal point (DP):

The numerator block can also be chosen with the decimale point. In this case, having five digit rings, the decimal position is so available:

- DP = 0 - no decimal point indicated (00000)
- DP = 1 - one decimal place indicated (0000.0)
- DP = 2 - two decimal place indicated (000.00)
- DP = 3 - three decimal place indicated (00.000)
- DP = 4 - four decimal place indicated (0.0000)

Base gasket seal for case seal:

Each numerator comes with a black foam polyurethane base case seal. To have add-ons order code K607067.

SPECIAL REQUESTS:

- On request can be supplied a shaft reducing bush K605 on black-oxide steel, diameters available: 08 - 10 - 12 - 14 - 18.
- On request numerator block can be supplied with anti-rotation pin for backlash compensation.
- On request can be supplied a case intermediate prolongs base (K606067).



Mounting/Reading position

Rotation direction

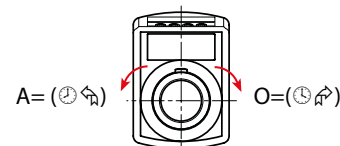
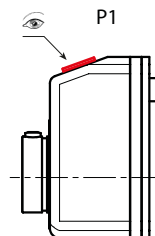

Numerator with 5 digit, 1 decimal

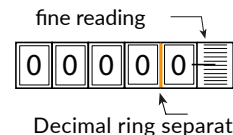
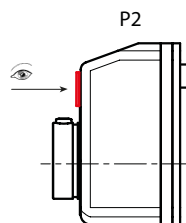

Base gasket seal for case K607067

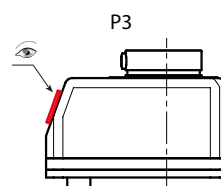

Case intermediate prolongs base K606067

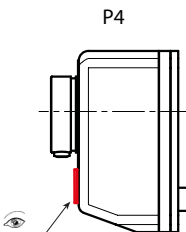

Reduction bush K605



Presumable presence in the stock in %

90%

40%

5%

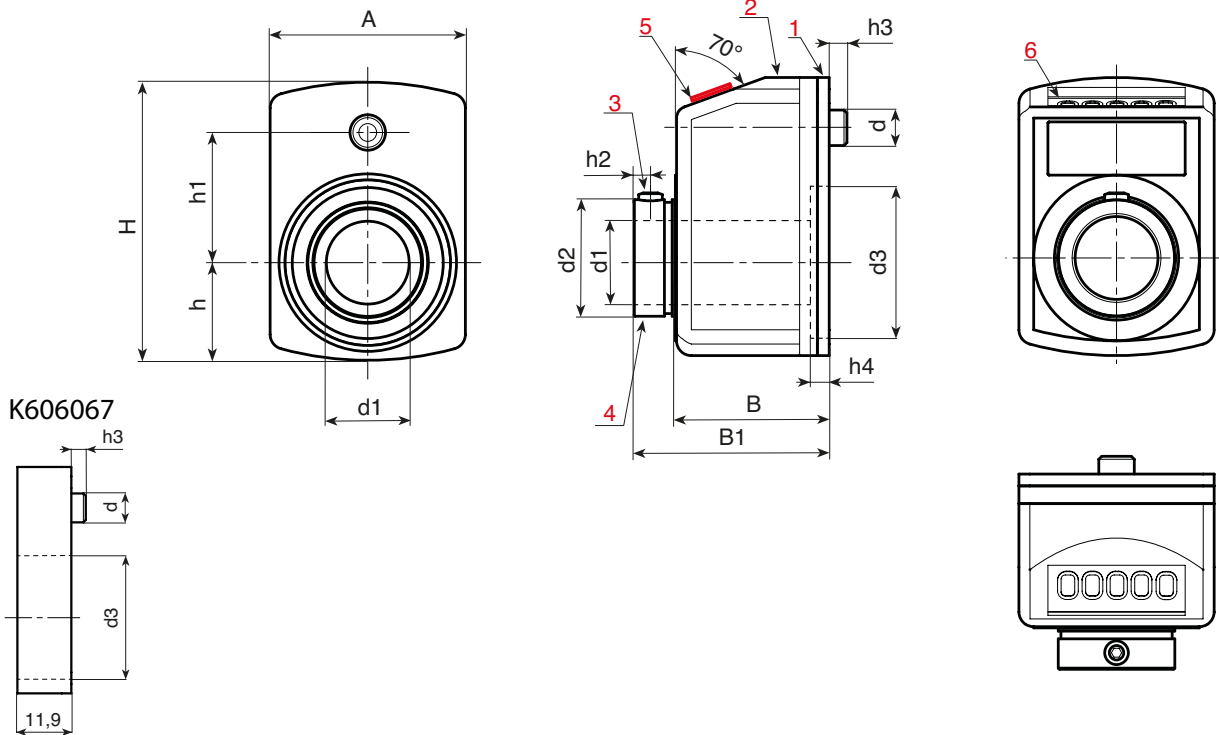

K606067

options to specify when ordering

art.	H	A	h	h1	h2	h3	h4	B	B1	d	d2	d3	d1 H7	GR	⌚ ↻	👁	DP	g	
● K620067.TD █	67,5	48	25,5	30	3,5	6	2	30	38,5	6	27	40	20	10- 12/5 -15- 15/75 17/5 -20-25-30- 39/375 40-50-60- 78/75 -80-100	○	👁	P1 P2 P3 P4	0 1 2 3 4	100
● K622067.TD █	67,5	48	25,5	30	3,5	6	2	30	38,5	6	27	40	20	10- 12/5 -15- 15/75 17/5 -20-25-30- 39/375 40-50-60- 78/75 -80-100	○	👁	P1 P2 P3 P4	0 1 2 3 4	100
● K623067.TD █	67,5	48	25,5	30	3,5	6	2	30	38,5	6	27	40	20	10- 12/5 -15- 15/75 17/5 -20-25-30- 39/375 40-50-60- 78/75 -80-100	○	👁	P1 P2 P3 P4	0 1 2 3 4	100
● K620067.TD CIN █	67,5	48	25,5	30	3,5	6	2	30	38,5	6	27	40	20	10- 12/5 -15- 15/75 17/5 -20-25-30- 39/375 40-50-60- 78/75 -80-100	○	👁	P1 P2 P3 P4	0 1 2 3 4	100
● K622067.TD CIN █	67,5	48	25,5	30	3,5	6	2	30	38,5	6	27	40	20	10- 12/5 -15- 15/75 17/5 -20-25-30- 39/375 40-50-60- 78/75 -80-100	○	👁	P1 P2 P3 P4	0 1 2 3 4	100
● K623067.TD CIN █	67,5	48	25,5	30	3,5	6	2	30	38,5	6	27	40	20	10- 12/5 -15- 15/75 17/5 -20-25-30- 39/375 40-50-60- 78/75 -80-100	○	👁	P1 P2 P3 P4	0 1 2 3 4	100

/5 arithmetic values not displayed

When ordering, instead of the code points, please enter the chosen options.

Example 1: for a numerator block with 5 digits (K620067) with shaft of 20 mm (d1), - orange colour (K622), - with gear reduction ratio (GR) 60 ; - with clockwise rotation (⌚ ↻) O, - with reading position (👁) P2, - with four decimal places (DP) 4 ; the complete code is thus formed: **K622067.TD20060OP24**

or:

Example 2: for a numerator block with 5 digits (K620067) with stainless steel shaft of 20 mm (d1) - black colour (K620), - with gear reduction ratio (GR) 15/75 ; - with counterclockwise rotation (⌚ ↻) A, - with reading position (👁) P3, - with four decimal places (DP) 4 ; the complete code is thus formed: **K620067.TD201575AP24CIN**